

**LUXMATE
DIMLITE**

Practical guidelines



LUXMATE DIMLITE

Ideal entry-level lighting control system



The DIMLITE system was developed to make it easier to get into the world of lighting management: DIMLITE is a simple lighting **control system for individual rooms**. Whether you are a designer, installing electrician or end user, you will not need any training or a specialist technician because the system manages entirely without any commissioning or addressing.

The DIMLITE basic module is available in four different versions, which offer an ascending range of functions. What is practical is that functions use the same logic across the entire range and that makes operation even easier. This way you can be sure of finding the perfect equipment for every application.

Our product range includes:

- Complete packages with a control module and control unit
- All the products needed to control luminaires via infra-red sensors or an infra-red remote control
- All the modules needed for daylight-based control

zumtobel.com/dimlite

There are various ways of using lighting control systems **to cut energy consumption**. All of them are based on digital dimmable luminaires.



Luminaires dimmed by a presence detector can save **15–30%** of energy.



Luminaires dimmed manually by momentary-action switches can save **30%** of energy.



Luminaires automatically dimmed by daylight-based control can save **40–60%** of energy.

DIMLITE individual room control

Little effort, huge effect

DIMLITE basic modules

	Size of system			Functions			Components that can be integrated			
	Number of groups	Number of DALI luminaires	Number of DSI luminaires	Dimming	Lighting scene	Control by momentary-action switch	Presence detector	Daylight-based control	Convenient control point	Remote control
DIMLITE single	1	25	25	•	•	•	•			
DIMLITE daylight	2	50	50	•	•	•	•	•		
DIMLITE 2ch	2	50	100	•	•	•	•	•	•	•
DIMLITE 4ch	4	100	200	•	•	•	•	•	•	•

To be installed in luminaire or recessed into ceiling



DIMLITE single: Quick problem-solver for synchronous dimming and presence-based control



DIMLITE daylight: World champion energy saver for daylight-based dimming and presence-based control.

DIMLITE compared with other lighting control systems

	1 – 10 V	KNX	DIMLITE
Data line	Separate line Analogue signal 1 – 10 V	Two bus systems (KNX and DALI or 1 – 10V)	The same cable can be used for data signals and mains power
Functions	Various units are required for implementing different functions	Various units are required for implementing different functions	Control unit with direct DALI/DSI output for switching and dimming, for daylight-based and presence-based control (on/off, only-off and corridor function)
Dimming levels	Different brightness levels due to conduction losses	DALI gateway required for uniform brightness levels	Uniform brightness thanks to unambiguous digital dimming commands
System expansion	Single units provide various combinations of functions	Add-on modules	Using additional modules, many functions are available via AUTO set-up and, accordingly, without commissioning
Commissioning	Broadcast signal	Commissioned using PC with software that must be paid for	Broadcast without any particular commissioning or addressing
Commissioned by	Electrician	Trained qualified personnel	Electrician
Functionality	Can be used immediately	Must be programmed before testing and functioning	Can be used immediately

To be installed in switch cabinet



DIMLITE multifunction 2ch and 4ch: multifunctional device with many energy-saving and convenience functions, Plug & Play installation using AUTO setup.

Plug & Play

Just a few steps to implement an energy-saving lighting solution

1



DIMLITE basic modules are universally usable units that can be supplemented by expansion components such as presence detectors, light sensors or scene modules. These are simply ordered separately.

2



A screwdriver is the only tool that an electrician needs to install a DIMLITE lighting control system. First of all install the basic unit in the switch cabinet ...

3



... then connect the luminaires. Cabling can be performed using standard commercially available NYM materials. In the case of digital control by DALI or DSI, the outlets are protected against polarity reversal.

4



Then connect the appropriate sensors and control units to Control In on the DIMLITE basic module. No additional device in the switch cabinet is necessary, ...

5



... The basic unit initialises itself in just a few seconds. The green LED indicates that the system is ready for service. That's "Plug & Play" in the truest sense of the word.

6



The system is then ready to operate. Lighting scenes can be modified and daylight characteristics can be adjusted as required.

Daylight-based control

A better alternative to daylight-based dimming

Daylight-based dimming

Most commercially available systems for saving energy use an indoor sensor that measures the reflective area directly below the sensor (look-down).

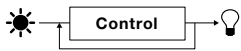
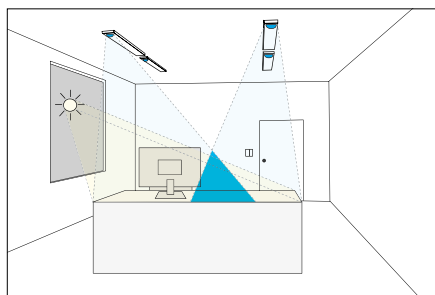

Closed-loop control

Sensors installed in the ceiling or in luminaires measure the total artificial light and daylight reflected by surfaces. The output value of the controller is also measured and it is therefore a closed-loop control system.

Influence of reflections

If the reflectance value changes, e.g. due to a white newspaper being spread out on a dark desktop, the control function reduces the artificial light, even though the prevailing daylight conditions in the room remain unchanged.

Installation

The measuring ranges of several sensors must not overlap. Luminaires could interfere with each other, and this would result in lighting fluctuations. If reflective surfaces change (e.g. furniture is brought in) after installation, this also has undesirable effects.

Application area

The sensitivity of the sensor is usually too low to ensure good lighting control in rooms with ceiling heights of more than 3 m.

Commissioning

Involves considerable effort because each sensor must be set up individually. This job has to be repeated every time a unit is replaced.

Cluttered ceiling look

Because each sensor operates with its own setpoint, this may result in messy patches of light on the ceiling.

Daylight-based control

Zumtobel exclusively uses the more robust method of daylight-based control and the open-loop control method that is preferred by scientists – using just a single sensor which selectively measures incoming daylight but is unaffected by artificial lighting and its reflections (look-out).

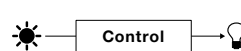
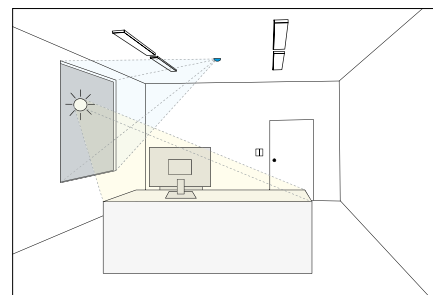

Open-loop control

The sensor is installed so that it faces the window. It therefore only measures incoming daylight. One control unit is used to add only as much artificial light as required by the prevailing daylight situation.

Not adversely affected by reflections

The great difference is that, with this method of control, the output value for artificial light is not measured. So, if furniture or fixtures change, there is no need to adjust the daylight-based control system.

Installation

Only one sensor per room is required. This ensures stable, robust monitoring of daylight – even if several groups of luminaires in the room are dimmed to different levels. Because fewer sensors and less equipment cost less, payback periods are extremely short.

Application area

The sensor can be used for rooms with any ceiling height and is therefore absolutely perfect for industrial buildings with skylights.

Commissioning

Every group of luminaires is given an appropriate control characteristic equivalent to the daylight factor in question; this requires just a few simple steps. Artificial lighting is dimmed to save energy with just one sensor – a robust and reliable solution.

Uncluttered ceiling look

Rows of luminaires are uniformly dimmed and are not affected by localised reflections. The ceiling has a uniform look.

Daylight-based control system

This is how simple commissioning can be

At the time of commissioning, each group of luminaires in the room is given an appropriate control characteristic for its daylight factor. As the illustrated story on the next page shows, taking the example of a DIMLITE control system, this setting is very easy to make and only has to be done once. Only a standard light meter is required to do this. This luxmeter is used to accurately set the desired lighting level.

It is usually sufficient to program the so-called day point. This can be accomplished at any time of day, ideally while it is quite light outdoors. However, the sensor must not be exposed to direct sunlight. Twilight and night time are not suitable.

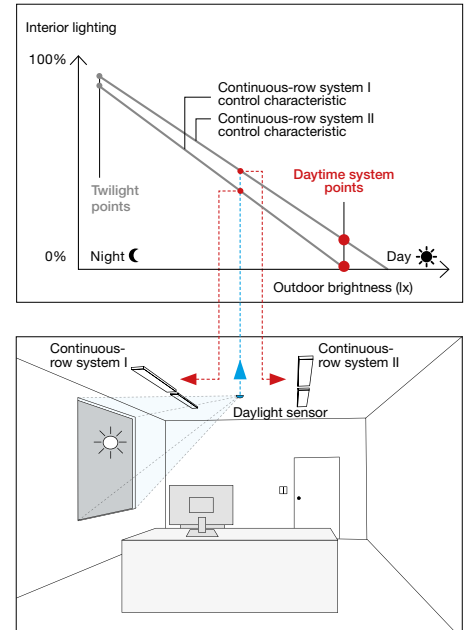

Precisely defining the daylight measuring point is an important detail in order for daylight-based control to work properly. In the case of Zumtobel DIMLITE this can be done in just a few simple steps. The system needs only a small number of modules and units, is easy to install and is very reliable in operation.

Daylight-based control system

This is how simple commissioning can be

1 Rows of luminaires and a light sensor have been installed, it is time for commissioning.



2 Pick up your luxmeter and screwdriver.



3 Measure the illuminance level underneath each row of luminaires at a relevant location.



4 Then manually dim the rows of luminaires ...



5 ... until the required lighting intensity (e.g. 500 lx in an office) is obtained.



6 Then press the screwdriver into the light sensor's opening once.



7 The luminaires briefly flash, the day point has been stored.



Practical tips

- It is vital to use a luxmeter, as the human eye cannot distinguish illuminance levels.
- A lighting control system operates slowly in order to ensure smooth lighting changes. When setting dimming levels, therefore always wait around 1 minute and then take a check measurement.
- The stored twilight point is factory set at 100% but can be modified if required. One tip: Mask the sensor (for longer than 1 minute), then adjust the artificial light (allowing for the maintenance factor, a level of around 80% is usually sufficient in the case of new systems) and press briefly into the light sensor's opening. The distinction between daylight and twilight point is made by the DIMLITE system independently. The limit is a level of 312 lx.
- Positioning the sensor correctly is just as important as measuring the illuminance level accurately. Do not install it too close to the window, but it must nevertheless have an unobstructed view of the window. No direct or indirect light from artificial light sources must impinge on the sensor. Precise instructions can be found in the daylight sensor's installation instructions. These can be found online at www.zumtobel.com/20731906
- A rough-and-ready check of the system ("Is it actually working?") can be carried out in daylight by covering the sensor or, when it is dark, shining a torch on the sensor.

Room type 1

Small classroom

Non-controlled solution

- Lighting is switched on 100% every day
- The required illuminance level (300 lx) is occasionally overshoot and undershot
- There is no possibility of dimming
- Lighting is sometimes left switched on overnight using unnecessary energy

Objectives of lighting control

- Save energy costs
- Improve user convenience

Functions for achieving objectives

- Daylight-based lighting management
- Presence-based management
- Manual dimming

Functional description



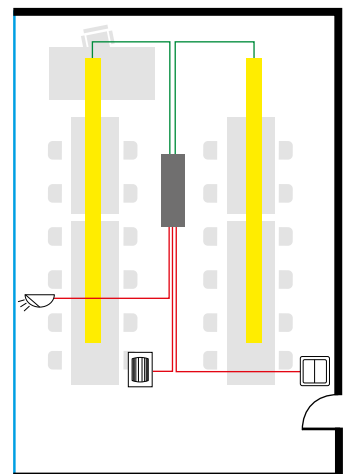

DIMLITE daylight offers the possibility of switching the two groups of luminaires on and off individually and dimming them manually.

The LSD look-out sensor is used to control the individual groups of luminaires in a daylight-based manner depending on outdoor brightness in order to save energy while ensuring the required illuminance of 300 lx.

A presence detector combined with DIMLITE's Only-OFF function makes sure that the lighting is never switched on when nobody is present or it is not needed. The delay time has to be set on the presence detector. There is no risk of the lighting being inadvertently switched on by the presence detector when entering the classroom thanks to the Only-OFF function. The lighting always has to be switched on manually by the momentary-action switch.



The package includes

	1 × DIMLITE daylight
	1 × LSD light sensor
	1 × standard presence detector
	1 × standard double momentary-action switch
	DALI dimmable luminaires

Room type 2

Medium-size to large classroom

Non-controlled solution

- Lighting is switched on 100% every day
- There is only one lighting scene for all teaching methods
- There is no possibility of dimming
- Lighting is sometimes left switched on overnight

Objectives of lighting control

- Save energy costs
- Improve user convenience
- Improve flexibility

Functions for achieving objectives

- Daylight-based lighting management
- Presence-based management
- Programmed lighting scenes at the touch of a button
- Manual dimming

Functional description

Four groups of luminaires can be switched on and off and dimmed separately or together on the DIMLITE multifunction.

Various sensors and control units can be connected to the unit's Control-IN input:

Look-out sensor ED-EYE is used to control the individual groups of luminaires in a daylight-based manner depending on outdoor brightness in order to save energy while ensuring the required illuminance level.





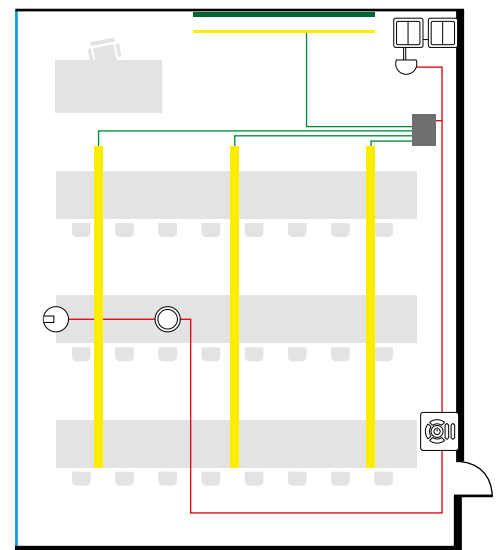

An ED-SENS presence detector combined with DIMLITE's Only-OFF function makes sure that the lighting is never switched on when nobody is present or it is not needed. The delay time can be set on DIMLITE multifunction 4 ch – from 0 s to 60 minutes. There is no risk of the lighting being inadvertently switched on by the presence detector when entering the classroom thanks to the Only-OFF function. The lighting always has to be switched on manually by the momentary-action switch.

In the entrance area there is an ED-CCW scene control unit, which can be used to switch all the lighting off and choose one of 3 presence scenes. Scene 1 is always based on daylight. Static scenes 2 and 3 can be individually set and called up.

Four standard momentary-action switches that make it possible to switch and dim the 4 individual groups of luminaires can be connected to momentary-action switch input module ED-SxED.



The package includes

	1 × DIMLITE multifunction 4 ch
	1 × ED-SxED switching/dimming input
	1 × ED-EYE light sensor
	1 × ED-SENS presence detector
	2 × standard double momentary-action switch
	1 × CIRCLE ED-CCW control point
	DALI dimmable luminaires

Room type 3

Secretary's office, office, small meeting rooms

Non-controlled solution

- Lighting is often switched on 100% throughout the day
- The required illuminance level (500 lx) is occasionally overshoot and undershot
- There is no possibility of dimming

Objectives of lighting control

- Save energy costs
- Improve user convenience

Functions for achieving objectives

- Daylight-based lighting management
- Presence-based management
- Lighting scenes
- Manual dimming

Functional description

The DIMLITE multifunction 2 ch basic module offers the possibility of switching the two groups of luminaires on and off individually and dimming them manually.

An ED-CCW scene control unit is located in the entrance area and at the other end of the office to allow control. Both groups of luminaires can be manually dimmed and individual scenes can be called up there. Scene 1 is always based on daylight. Static scenes 2 and 3 can be individually set.

Look-out sensor ED-EYE is used to control the individual groups of luminaires in a daylight-based manner depending on outdoor brightness in order to save energy while ensuring the required illuminance level of 500 lx.

A presence detector combined with DIMLITE's Only-OFF function makes sure that the lighting is never switched on when nobody is present or it is not needed. The delay time can be set on DIMLITE multifunction 4 ch – from 0 s to 60 minutes. There is no risk of the lighting being inadvertently switched on by the presence detector when entering the office room thanks to the Only-OFF function. The lighting always has to be switched on manually by the momentary-action switch.

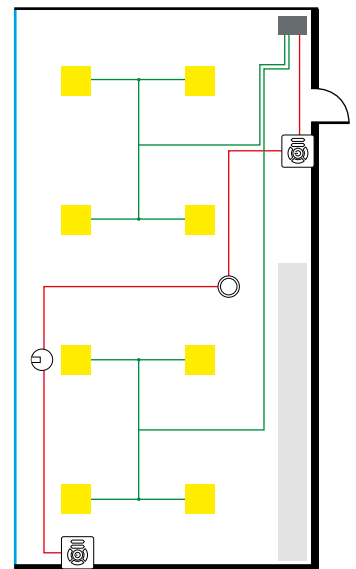

The package includes

- | | |
|---|---------------------------------|
| | 1 × DIMLITE multifunction 2 ch |
| ⊙ | 1 × ED-SENS presence detector |
| ⊖ | 1 × ED-EYE light sensor |
| ⊙ | 2 × CIRCLE ED-CCW control point |
| □ | DALI dimmable luminaires |

Room type 4

Shop, boutique

Non-controlled solution

- There is an either-only situation: The groups of luminaires are on or off
- It is not possible to respond to the various requirements of campaigns or events

Objectives of lighting control

- Improve user convenience

Functions for achieving objectives

- Programmed lighting scenes at the touch of a button
- Manual dimming

Functional description

On entering the boutique, the entire sales area is not brightened up, only the ambient lighting in the entrance area is switched on.



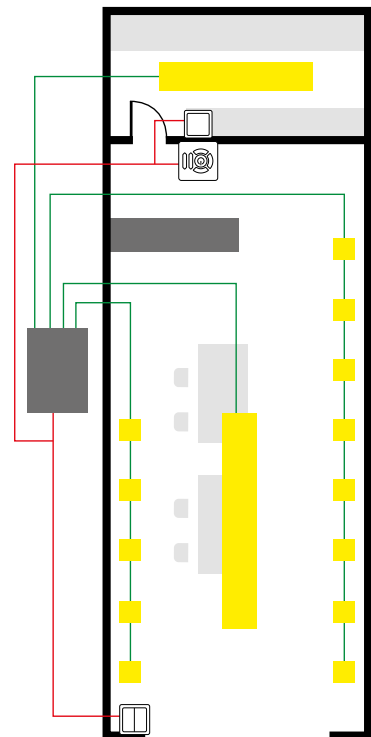

On exiting, it is possible to use the central all-off momentary-action switch to switch all the luminaires 100% off – without previously having walk through the dark room.

The appropriate lighting scene is selected using the CIRCLE control point in the POS area. This means that the various groups of luminaires do not have to be reset and matched to each other on a daily basis. Far from it: three programmed lighting scenes are available at the push of a button and can be adapted by the actual user or re-defined if required.

The separate luminaire in the stores is switched on and off by a momentary-action switch but can also be dimmed. It is also switched off using the central momentary-action switch so that precious energy is not inadvertently used overnight.



The package includes

	1 × DIMLITE multifunction 4 ch
	1 × CIRCLE ED-CCW control point
	2 × ED-SxED switching/dimming input
	1 × standard momentary-action switch
	1 × standard double momentary-action switch
	DALI-dimmable luminaires

Room type 5

Stores, archive

Non-controlled solution

- All areas, even those that are not being used, are switched on 100%

Objectives of lighting control

- Save energy costs

Functions for achieving objectives

- Presence and absence-based management
- corridorFUNCTION

Functional description

In the areas between the shelves, 100% lighting is required only if at least one person is present. ED-SENS presence detectors can be allocated to individual luminaire groups and will dim up a specific luminaire group to 100% only when somebody is present in the area they cover. As manual operation is not necessary, no cumbersome positioning and wiring of control units is required, since the lighting is switched on by the corridor function when people are present and is dimmed down to 10% when nobody is present. This ensures that people never have to enter dark corridors, promoting a feeling of safety and well-being.

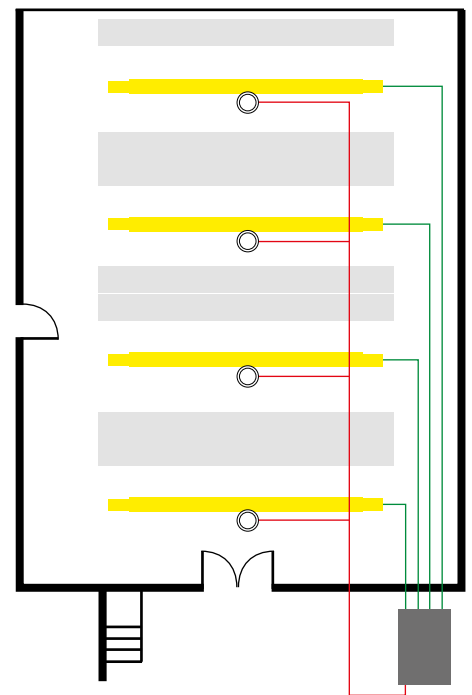

The package includes

- 1 × DIMLITE multifunction 4 ch
- 4 × ED-SENS presence detector
- DALI dimmable luminaires

Room type 6

Corridor, passageway

Non-controlled solution

- Lighting can only be switched on or off 100%
- Lighting usually remains switched on

Objectives of lighting control

- Save energy costs
- Improve safety

Functions for achieving objectives

- corridorFUNCTION

Functional description

The corridor function on the DIMLITE single basic module and the connected presence detectors switch on the lighting 100%, or switch it to the previously set light level if people are present. If there is no one within the area monitored by the presence detector, the luminaires dim down to 10% within approximately 1 minute. The delay time is set on the presence detector.

The advantage of the 10% minimum level is that no one has to enter a dark room and wait until they are detected by the presence detector. This also provides the necessary ambient lighting in case of video surveillance. An additional momentary-action switch can be used to switch the lighting on or off as required, regardless of the presence detectors.

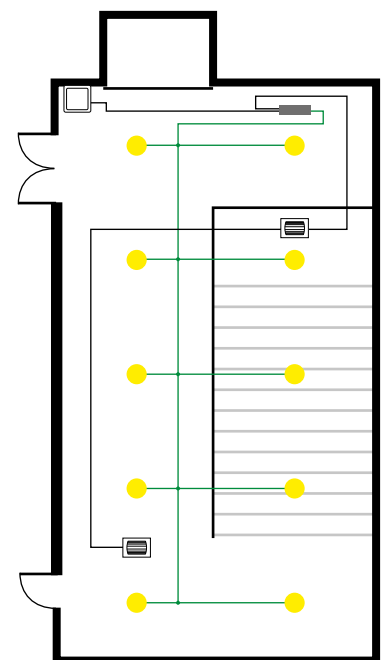

The package includes

- 1 × DIMLITE single
- 1 × standard momentary-action switch
- 2 × standard presence detector
- DALI dimmable luminaires

Room type 7

WC facilities

Non-controlled solution

- Lighting is often switched on 100% throughout the day
- Due to the service life of compact fluorescent lamps, presence-based control is dispensed with

Objectives of lighting control

- Save energy costs

Functions for achieving objectives



- Presence and absence-based management
- corridorFUNCTION

Functional description

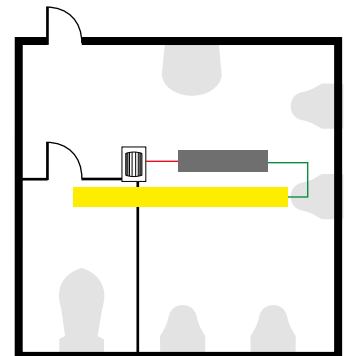
The presence detector switches the lighting on when people are present and dims it down to 10% when nobody is present. The delay time is set directly at the presence detector. This ensures that people never have to enter a dark room, especially in public toilets. Yet, compared to installations where the lighting is maintained at 100% all the time, plenty of energy is saved.



The package includes

	1 × DIMLITE single
	1 × standard presence detector
	DALI dimmable luminaires



Track and spots

United Kingdom

Zumtobel Lighting Ltd.
Chiltern Park
Chiltern Hill, Chalfont St. Peter
Buckinghamshire SL9 9FG
T +44/(0)1753 482 650
F +44/(0)1753 480 350
uksales@zumtobel.com
zumtobel.co.uk

Romania

Zumtobel Lighting Romania SRL
Tipografilor 11-15,
S-Park Office, Wing A1-A2
013714 Bucharest
T +40 312253801
F +40 312253804
welcome.ro@zumtobel.com
zumtobel.com

Russia

Zumtobel Lighting GmbH
Official Representative Office
Skakovaya Str. 17
Bld. No 1, Office 1104
125040 Moscow
T +7/(495) 945 3633
F +7/(495) 945 16 94
info-russia@zumtobel.com
zumtobel.ru



Modular lighting systems

USA and Canada

Zumtobel Lighting Inc.
17-09 Zink Place, Unit 7
Fair Lawn, NJ 07410
3300 Route 9W
Highland, NY 12528
T +1/(0)845/691 6262
F +1/(0)845/691 6289
zli.us@zumtobel.com
zumtobel.us

Hungary

Zumtobel Lighting Kft
Váci út 49
1134 Budapest
T +36/(1) 35 00 828
F +36/(1) 35 00 829
welcome@zumtobel.hu
zumtobel.hu

Norway

Zumtobel Belysning
Hoffsveien 4
Postboks 1025 Hoff
0218 Oslo
T +47 22 06 50 50
firmapost@zumtobel.com
zumtobel.no



Downlights

Australia and New Zealand

Zumtobel Lighting Pty Ltd
333 Pacific Highway
North Sydney, NSW 2060
T +61/(2)8913 5000
F +61/(2)8913 5001
info@zumtobel.com.au
zumtobel.com.au

Croatia, Bosnia and Herzegovina

Zumtobel Licht d.o.o.
Radnička cesta 80 – Zagrebtower
10000 Zagreb
T +385/(1) 64 04 080
F +385/(1) 64 04 090
welcome@zumtobel.hr
welcome.ba@zumtobel.com

Sweden

Zumtobel Belysning
Birger Jarlsgatan 57
113 56 Stockholm
T +46 8 26 26 50
info.se@zumtobel.com
zumtobel.se



Recessed luminaires



Surface-mounted and pendant luminaires

China

Zumtobel Lighting China
Shanghai office
Room 101,
No 192 YIHONG Technology Park
Tianlin Road, Xuhui District
Shanghai City, 200233, P.R. China
T +86/(21) 6375 6262
F +86/(21) 6375 6285
sales.cn@zumtobel.com
zumtobel.cn

Serbia

Zumtobel Licht d.o.o.
Karadjordjeva 2-4
Beton Hala
11000 Belgrade
T +381/(0)11 65 57 657
F +381/(0)11 65 57 658
welcome@zumtobel.rs

Denmark

Zumtobel Belysning
Store Kongensgade 118
1264 København
T +45 35 43 70 00
info.dk@zumtobel.com
zumtobel.dk



Free-standing and wall-mounted luminaires

Hong Kong

Zumtobel Lighting Hong Kong
Unit 4319-20, Level 43,
Tower 1, Metroplaza,
223 Hing Fong Road,
Kwai Fong, N.T.
T +852/(0)2503 0466
F +852/(0)2503 0177
info.hk@zumtobel.com

Czech Republic

Zumtobel Lighting s.r.o.
Jankovcova 2
Praha 7
170 00 Praha
T +420/(2) 66 782 200
F +420/(2) 66 782 201
welcome@zumtobel.cz
zumtobel.cz

Headquarters

Zumtobel Lighting GmbH
Schweizer Strasse 30
Postfach 72
6851 Dornbirn, AUSTRIA
T +43/(0)5572/390-0
F +43/(0)5572/22 826
info@zumtobel.info



Continuous-row systems and individual batten luminaires

Slovak Republic

Zumtobel Lighting s.r.o.
Vičie Hrdlo 1,
824 12 Bratislava
welcome@zumtobel.sk
zumtobel.sk

Zumtobel Licht GmbH
Grevenermarchstrasse 74-78
32657 Lemgo, GERMANY
T +49/(0)5261 212-0
F +49/(0)5261 212-7777
info@zumtobel.de



High-bay luminaires and floodlight reflector systems

India

Zumtobel Lighting GmbH
1522, Devika Tower,
6, Nehru Place,
110019 New Delhi
T +91/11 4601 2782
info.in@zumtobel.com

zumtobel.com

Poland

Zumtobel Licht GmbH Sp.z.o.o.
Platinum III
ul. Woloska 9a
02-583 Warszawa
T +48/(22) 856 74 31
F +48/(22) 856 74 32
welcome@zumtobel.pl
zumtobel.pl



Luminaires with extra protection

Singapore

Zumtobel Lighting Singapore
158 Kallang Way # 06-01/02
Singapore 349245
T +65 6844 5800
F +65 6745 7707
info.sg@zumtobel.com

Slovenia

Zumtobel Licht d.o.o.
Štukljeva cesta 46
1000 Ljubljana
T +386/(1) 5609 820
F +386/(1) 5609 866
welcome@zumtobel.si
zumtobel.si

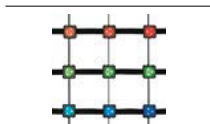

Façade, media and outdoor luminaires



Lighting management system



Emergency lighting

United Arab Emirates

Zumtobel Lighting GmbH (Branch)
Dubai Airport Free Zone,
Building 6W, B Block, 233
PO Box 54302
Dubai
T +971/(0)4 299 3530
F +971/(0)4 299 3531
info@zumtobeluae.ae



Medical supply systems